

Medical AC-DC Power Supply

24 V 500 W 1 Phase / MEB-500A24F AA

MEB-500



Highlights & Features

- Safety Approvals to IEC 60601-1 & IEC 60950-1 & IEC 62368-1
- Compliant with IEC 60601-1-2 4th Ed. Requirements
- High Power Density
- Built-in Remote On/Off
- 5 V/1 A Standby Output
- 12 V/0.5 A Fan Output for System
- IT & Medical Safety Approvals

Safety Standards



CB Certified for worldwide use

Model Number: MEB-500A24F AA
Unit Weight: 0.66 kg (1.455 lb)
Dimensions (L × W × H): 165.3 × 85.2 × 41 mm
 6.5 × 3.35 × 1.61 inch

General Description

The MEB-500A24F AA of internal Panel Mount power supplies come with universal AC input range from 90 Vac to 264 Vac. Other features include low voltage, Type BF Patient Access Leakage Currents, and electric shock protection compliance with 2 x MOPP requirements. The MEB-500A24F AA is certified for EMC standards according to EN/BS EN 55011 for industrial, scientific and medical (ISM) radio-frequency equipment; and, compliance with EN/BS EN 55032 for Industrial Technology Equipment (ITE) radio-frequency equipment.

This model comes with both medical and ITE safety approvals, including UL/CE, and CB certification. Designs are compliant with RoHS Directive for environmental protection.

Model Information

MEB Panel Mount Power Supply

Model Number	Input Voltage Range	Rated Output Voltage	Rated Output Current
MEB-500A24F AA	90-264 Vac	24 Vdc	21 A

Model Numbering

						CC Code	
MEB	500	A	24	F	□	A	A
MEB Series	Output power	Family code	Output voltage	Front face connector	Blank	Remote On/Off	Coating

Medical AC-DC Power Supply

24 V 500 W 1 Phase / MEB-500A24F AA

Specifications

Input Ratings / Characteristics

Nominal Input Voltage	100-240 Vac ¹⁾
Input Voltage Range	90-264 Vac
Nominal Input Frequency	50-60 Hz
Input Frequency Range	47-63 Hz
Input Current (Rated Output Current)	5 A typ. @ 120 Vac , 2.6 A typ. @ 230 Vac
Input Surge Voltage (max)	300 Vac for 100 ms
Efficiency	92% typ. @ 230 Vac
Standby Power (max)	0.5 W (only standby working with Inhibit signal high) @ 115 Vac/60 Hz, 230 Vac/50 Hz
Inrush Current	40 A typ. @ 230 Vac, Cold start, @ 25°C
Power Factor	0.98 typ. @ 115 Vac, 0.96 typ. @ 230 Vac
Input-PE (protective earth) leakage current (max)	0.25 mA @ NC, 0.5 mA @ SFC ²⁾
Output-PE (protective earth) leakage current for Type BF application (max)	0.1 mA @ NC, 0.3 mA @ SFC ²⁾

1) 100-120V, 200-240V safety approval

2) NC: normal condition, SFC: single fault condition, @264Vac

Output Ratings / Characteristics

Nominal Output Voltage	24 Vdc
Factory Set Point Tolerance	24 Vdc \pm 1% @ No Load
Output voltage adjustment range	21.6 V~26.4 V
Rated Output Current	21 A
Output Power	504 W
Static Line Regulation	96 mv max.
Static Load Regulation	150 mv max.
PAR [*] (20 MHz)	< 300 mVpp @ 0~+50°C < 360 mVpp @ -20~0°C
Rise Time	50 ms max.
Start-up Time	800 ms max.
Hold-up Time	16 ms typ. @ 120 Vac (100% load)
Dynamic Response (Overshoot & Undershoot O/P Voltage)	\pm 10% @50-100% load (Slew Rate: 0.1 A/ μ S, 50% duty cycle @ 100 Hz)
Start-up with Capacitive Loads	8,800 μ F Max

PAR^{} is measured with an AC coupling mode, and in parallel to end terminal with 0.1 μ F ceramic capacitor & 22 μ F electrolytic capacitor.

Medical AC-DC Power Supply

24 V 500 W 1 Phase / MEB-500A24F AA

Output Ratings / Characteristics — Standby Output

Nominal Output Voltage of Standby output **	5 V
Nominal Output Current of Standby output	1 A
Total Regulation of Standby output	± 5%
PARD* (20 MHz) of Standby output	300 mV max

*PARD is measured with an AC coupling mode, and in parallel to end terminal with 0.1 μF ceramic capacitor & 22 μF electrolytic capacitor.

**Recommend to add external capacitor 680 uF on this pin

Output Ratings / Characteristics — Fan Output

Nominal Output Voltage of Fan output	12 V
Nominal Output Current of Fan output	0.5 A
Total Regulation of Fan output	± 5%
PARD* (20 MHz) of Fan output	300 mV max

*PARD is measured with an AC coupling mode, and in parallel to end terminal with 0.1 μF ceramic capacitor & 22 μF electrolytic capacitor.

Ripple & Noise Measurement Circuit

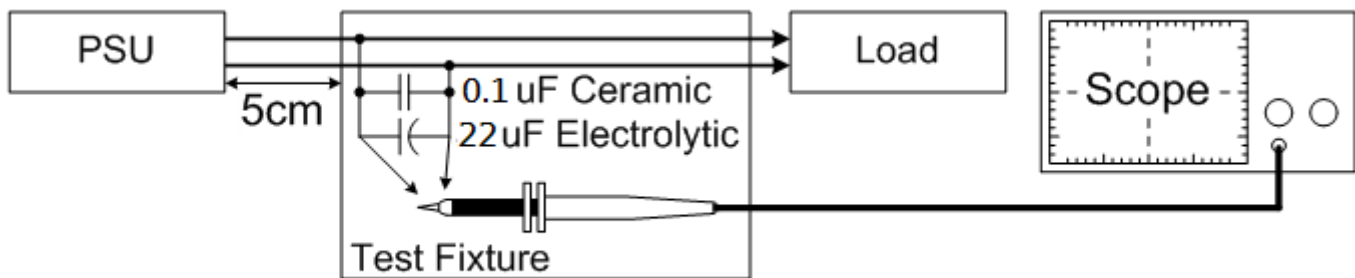

Mechanical

Casing	Aluminum						
Dimensions (L × W × H)	165.3 × 85.2 × 41 mm (6.5 × 3.35 × 1.61 inch)						
Unit Weight	0.66 kg (1.455 lb)						
Cooling System	Built-in Fan						
Terminal	<table border="0"> <tr> <td>Input</td> <td>M3.5 x 3 Pins (Rated 300 Vac/20 A)</td> </tr> <tr> <td>Output</td> <td>M4 x 2 Pins (Rated 300 Vac/25 A)</td> </tr> <tr> <td>CN600</td> <td> Connector: JST S8B-PHDSS(LF)(SN) Mating connector: Crimp Terminal: SPHD-002T-P0.5 (#28 to #24 AWG) or equivalent SPHD-001T-P0.5 (#26 to #22 AWG) or equivalent Housing: PHDR-08VS </td> </tr> </table>	Input	M3.5 x 3 Pins (Rated 300 Vac/20 A)	Output	M4 x 2 Pins (Rated 300 Vac/25 A)	CN600	Connector: JST S8B-PHDSS(LF)(SN) Mating connector: Crimp Terminal: SPHD-002T-P0.5 (#28 to #24 AWG) or equivalent SPHD-001T-P0.5 (#26 to #22 AWG) or equivalent Housing: PHDR-08VS
Input	M3.5 x 3 Pins (Rated 300 Vac/20 A)						
Output	M4 x 2 Pins (Rated 300 Vac/25 A)						
CN600	Connector: JST S8B-PHDSS(LF)(SN) Mating connector: Crimp Terminal: SPHD-002T-P0.5 (#28 to #24 AWG) or equivalent SPHD-001T-P0.5 (#26 to #22 AWG) or equivalent Housing: PHDR-08VS						
Wire	AWG 22-12						
Noise (1 Meter from power supply)	Sound Pressure Level (SPL) < 60 dBA						

Medical AC-DC Power Supply

24 V 500 W 1 Phase / MEB-500A24F AA

Environment

Surrounding Air Temperature	Operating	-20°C to +70°C
	Storage	-30°C to +80°C
AC De-rating		< 115 V de-rate power by 0.8% / V
Power De-rating		> 50°C de-rate power by 2.5% / °C
Operating Humidity		20 to 90% RH (Non-Condensing)
Operating Altitude		0 to 3,000 Meters (9,840 ft.) - IEC 60601-1
		0 to 5,000 Meters (16,400 ft.) - IEC 60950-1 & IEC 62368-1
Shock Test	Operating	IEC60068-2-27, Half Sine Wave: 10 G for a duration of 11 ms, 3 shocks for each 3 directions
Vibration	Operating	IEC60068-2-6, Sine Wave: 10 Hz to 55 Hz@19.6 m/s ² (2G peak); 10 min per cycle, 60 min per axis for all X,Y,Z direction
Pollution Degree		2

Protections

Overvoltage		115-140% (27.6 – 33.6 V) 105-150% (5.25 – 7 V) Protection mode: Latch OFF
Overload / Overcurrent		>105% rated full load current, Hiccup Mode, Non-Latching (Auto-Recovery when the fault is removed)
Over Temperature		Protection mode: Latch OFF
Short Circuit		Hiccup Mode, Non-Latching (Auto-Recovery when the fault is removed)
Protection Against Shock		Class I with PE* connection

*PE: Primary Earth

Reliability Data

MTBF		> 700,000 Hrs. Based on Telecordia SR-332 I/P: 115 Vac, O/P: 100% load, Ta: 25°C
Expected Cap Life Time		3 years (115 Vac, 100% load @ 50°C)

Medical AC-DC Power Supply

24 V 500 W 1 Phase / MEB-500A24F AA

Safety Standards / Directives

Medical Safety	IEC 60601-1 CB report TUV EN 60601-1 UL 60601-1 + ANSI/AAMI ES60601-1 + CAN/CSA 60601-1	
ITE Safety	IEC 60950-1 & IEC 62368-1 CB report TUV 60950-1 UL 60950-1 + CAN/CSA 60950-1 CCC GB 17625.1; GB 4943.1; GB/T 9254.1	
CE	In conformance with EMC Directive 2014/30/EU and Low Voltage Directive 2014/35/EU EN 60601-1: 2006 + A11: 2011 + A1: 2013 + A12: 2014 & EN 60601-1-2: 2015	
UKCA	In conformance with Electrical Equipment (Safety) Regulations 2016, and Electromagnetic Compatibility Regulations 2016, Medical Devices Regulations 2002(UK MDR 2002)	
Galvanic Isolation	Input to Output (2XMOPP)	4.0 KVac
	Input to Earth (1XMOPP)	1.5 KVac ¹⁾
	Output to Earth (1XMOPP)	1.5 KVac (Type BF application rated)

1) PSU can support Primary to FG 2500 Vac test condition according to IEC 62368-1.

Medical AC-DC Power Supply

24 V 500 W 1 Phase / MEB-500A24F AA

EMC (Compliant with IEC 60601-1-2 4th Ed. Requirements)

Emissions (CE & RE)		EN/BS EN 55011 & compliant with EN/BS EN 55032, FCC Title 47: Class B
Harmonic Current emissions	IEC 61000-3-2	Meet Class A limit
Immunity		
Electrostatic Discharge	IEC 61000-4-2	Level 4 Criteria A ¹⁾ Air Discharge: 15 kV Contact Discharge: 8 kV
Radiated Field	IEC 61000-4-3	Criteria A ¹⁾ 80 MHz-2700 MHz, 10 V/m AM modulation 385 MHz-5785 MHz, 28 V/m Pulse mode and other Modulation
Electrical Fast Transient / Burst	IEC 61000-4-4	Level 3 Criteria A ¹⁾ 2 kV
Surge	IEC 61000-4-5	Level 3 Criteria A ¹⁾ Common Mode ³⁾ : 2 kV Differential Mode ⁴⁾ : 1 kV
Conducted	IEC 61000-4-6	Level 2 Criteria A ¹⁾ 150 kHz-80 MHz, 3 Vrms, 6 Vrms at ISM bands and
Power Frequency Magnetic Fields	IEC 61000-4-8	Criteria A ¹⁾ Magnetic field strength 30 A/m
Voltage Dips	IEC 61000-4-11	Criteria A ¹⁾ 0% UT, 0.5 cycle (10 ms), 0°/45°/90°/135°/180°/225°/270°/315°/360° Criteria B ²⁾ 0% UT, 1 cycle (20 ms), 0° Criteria B ²⁾ 70% UT, 25 cycle (500 ms), 0° Criteria B ²⁾ 0% UT, 250 cycle (5000 ms), 0°

1) Criteria A: Normal performance within the specification limits

2) Criteria B: Output out of regulation, or shuts down during test. Automatically restore to normal operation after test.

3) Asymmetrical: Common mode (Line to earth)

4) Symmetrical: Differential mode (Line to line)

Medical AC-DC Power Supply

24 V 500 W 1 Phase / MEB-500A24F AA

Dimensions

L × W × H: 165.3 × 85.2 × 41.0 mm (6.5 x 3.35 x 1.61 inch)

Notes:

- Dimension are in mm.
- Built-in cooling fan. Must prevent dust suction into power supply, or use natural convection power supply if any concerns.

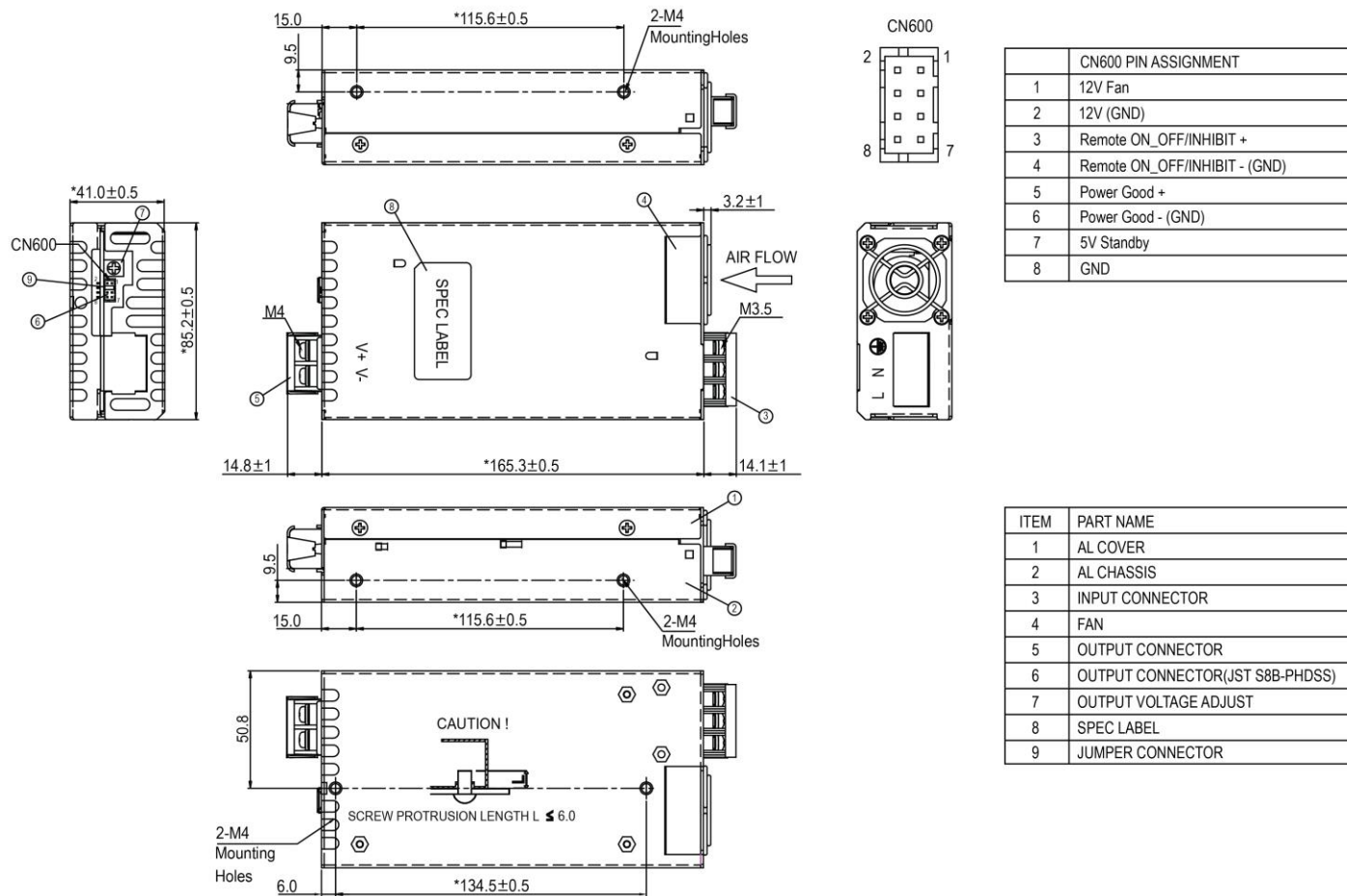

Medical AC-DC Power Supply

24 V 500 W 1 Phase / MEB-500A24F AA

Engineering Data

Output Load De-rating VS Surrounding Air Temperature

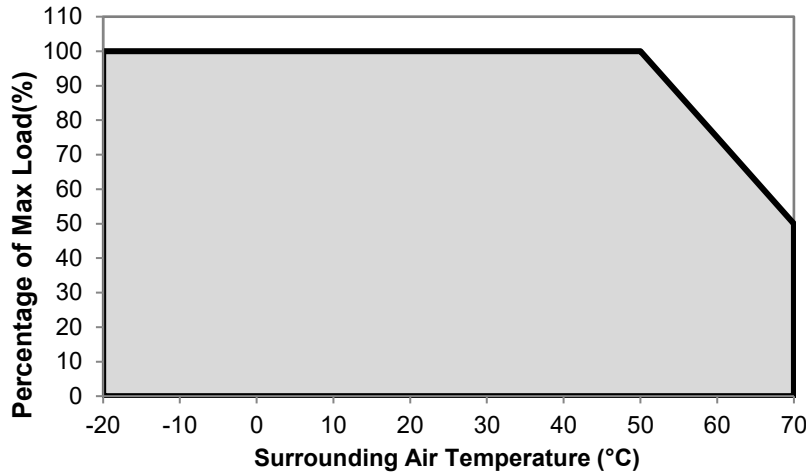
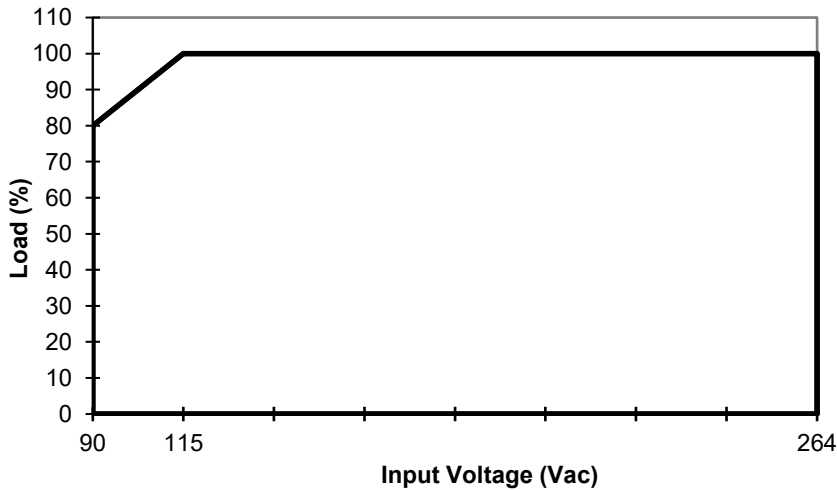

Fig. 1 De-rating for Vertical and Horizontal Mounting Orientation
 > 50°C de-rate power by 2.5% / °C

Note

1. Power supply components may degrade, or be damaged, when the power supply is continuously used outside the shaded region, refer to the graph shown in Fig. 1.
2. If the output capacity is not reduced when the surrounding air temperature exceeds its specification as defined on Page 3 under "Environment", the device may run into Over Temperature Protection. When activated, the output voltage will go into bouncing mode and will recover when the surrounding air temperature is lowered or the load is reduced as far as necessary to keep the device in working condition.
3. In order for the device to function in the manner intended, it is also necessary to keep a safety distance as recommended in the safety instructions while the device is in operation.
4. Depending on the surrounding air temperature and output load delivered by the power supply, the device can be very hot!
5. If the device has to be mounted in any other orientation, please leave a message via the [Contact Us](#) form.

Output Load De-rating VS Input Voltage



- No output power de-rating for the input voltage 115 Vac to 264 Vac

Medical AC-DC Power Supply

24 V 500 W 1 Phase / MEB-500A24F AA

Assembly & Installation

Mounting

- Ⓐ Mounting holes
- Ⓑ Input
- Ⓒ Output connector
- Ⓓ Mounting surface (customer system)
- Ⓔ DC FAN

Side Mounting (Horizontal)

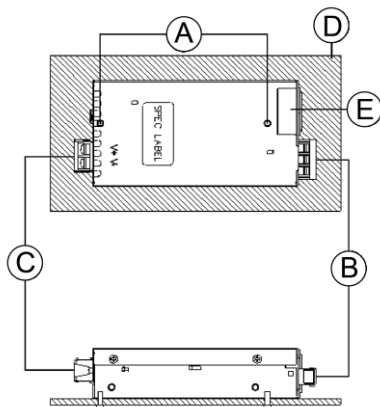
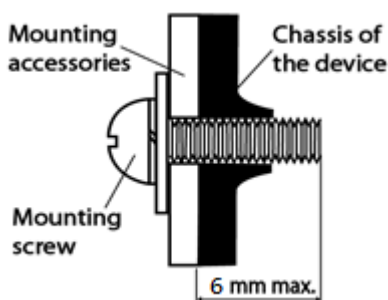

Fig. 2 Mounting Orientation

Installation



- Only use M4 screw ≤ 6 mm through the base mounting holes. This is to keep a safe distance between the screw and internal components.
- Recommended mounting tightening torque: 14.7 Kgf.cm max.

Safety Instructions

- To ensure sufficient convection cooling, always maintain a safety distance of > 20 mm from all ventilated surfaces while the device is in operation.
- The device is not recommended to be placed on low thermal conductive surface, for example, plastics.
- Note that the enclosure of the device can become very hot depending on the ambient temperature and load of the power supply. Do not touch the device while it is in operation or immediately after power is turned OFF. Risk of burning!
- Do not touch the terminals while power is being supplied. Risk of electric shock.
- Prevent any foreign metal, particles or conductors to enter the device through the openings during installation. It can cause: -- Electric shock; Safety Hazard; Fire; Product failure
- Warning: When connecting the device, secure Earth connection before connecting L and N. When disconnecting the device, remove L and N connections before removing the Earth connection.

Medical AC-DC Power Supply

24 V 500 W 1 Phase / MEB-500A24F AA

Functional Manual

Pin Assignment of CN600

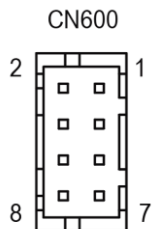

Pin	Functions	Descriptions
1	12 V Fan	Fan Voltage output 11.4 - 12.6 V, Reference to Pin 2 (GND). The maximum load current is 0.5 A
2	12 V Fan (GND)	Ground reference
3	Remote On/off	Turn the output on and off by electrical SW or dry contact between Pin 4 (GND); Short: Power ON, Open: Power OFF
4	Remote On/Off (GND)	Ground reference
5	Power Good +	Positive sensing. The +S Signal should be connected to the positive terminal of the load
6	Power Good – (GND)	Negative sensing. Ground reference
7	5 V STB	Standby Voltage output 4.75 – 5.5 V, Reference to Pin 8 (GND). The maximum load current is 1 A
8	5 V STB (GND)	Ground reference

Power Good

Power Good+ pin is an open drain transistor. A resistor (suggested value 10 Kohm, 1/8 W) can be added between 5 V STANDBY pin (CN 600 Pin 7) (or, other available pull-up voltage that is no greater than 30 V) and the Power Good+ pin (CN 600 Pin5). Value of pull-up resistor may have to be adjusted, depending on voltage used, and other end-use conditions of the Power Good+ pin connection to the product. When AC input is on, Power Good+ pin will be high. When AC input is off, Power Good+ pin will be low. There will be a minimum of 3 milliseconds between the time the power good goes to low level, and the time when the output reaches 90% of its rated value.



Medical AC-DC Power Supply

24 V 500 W 1 Phase / MEB-500A24F AA

Remote On_OFF (INHIBIT)

Remote ON_OFF (INHIBIT) can be used to enable or disable only the main output. When the main output is disabled, the +5 V Standby output will continue to operate. This signal can be pulled down to a low level of 0.3 volts, or shorted to Remote On/Off (GND), in order for the main output to be enabled; and, floated (no connection to the signal), or pulled up to a value greater than or equal to 3 volts & remove jumper at CN 600, in order to disable the main output.

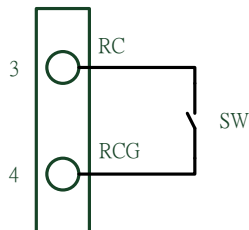

Between Remote On/Off (CN600 pin3) and Remote On/Off GND (CN600 pin4)	Output Status
SW ON (Short)	ON
SW OFF (Open)	OFF (Standby mode)

*Mating Jumper: Refer to page 3.

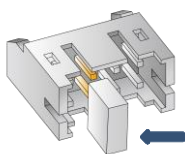

Mating Jumper for enable the main output (+24V)

Functions

■ Graph illustrating the Start-up Time, Rise Time, and Hold-up Time

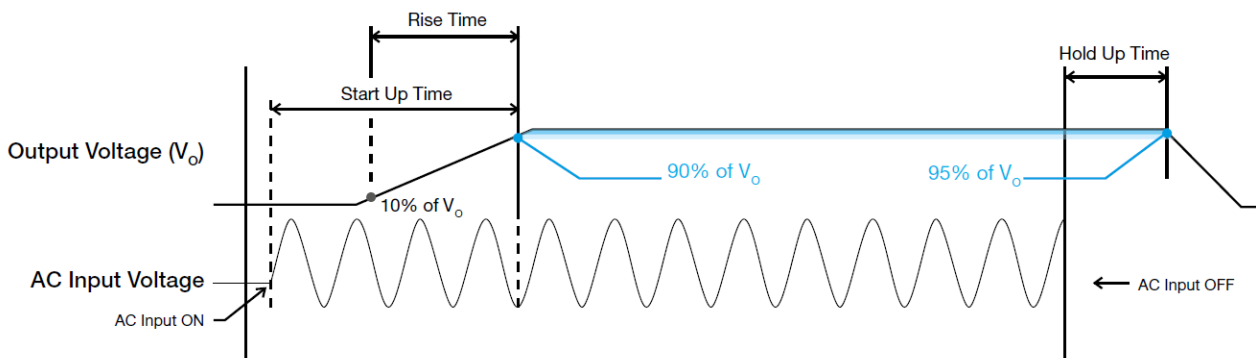

Start-up Time

The time required for the output voltage to reach 90% of its set value, after the input voltage is applied.

Rise Time

The time required for the output voltage to change from 10% to 90% of its set value.

Hold-up Time

Hold up time is the time when the AC input collapses and output voltage retains regulation for a certain period of time. The time required for the output to reach 95% of its set value, after the input voltage is removed.

Medical AC-DC Power Supply

24 V 500 W 1 Phase / MEB-500A24F AA

Inrush Current

Inrush Current is the first surge current seen on the input side when AC input is applied to the power supply. It is the first pulse captured; see a typical picture for the inrush current as seen in the power supply.

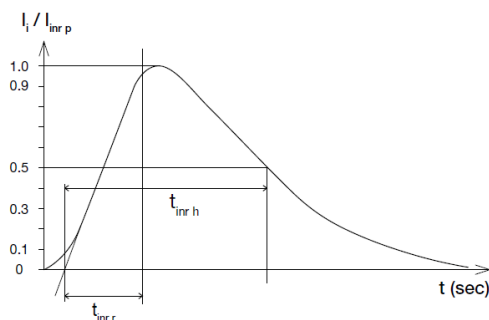

Dynamic Response

The power supply output voltage will remain within $\pm 10\%$ of its steady state value, when subjected to a dynamic load from 50% to 100% of its rated current.

■ 50% duty cycle / 100 Hz

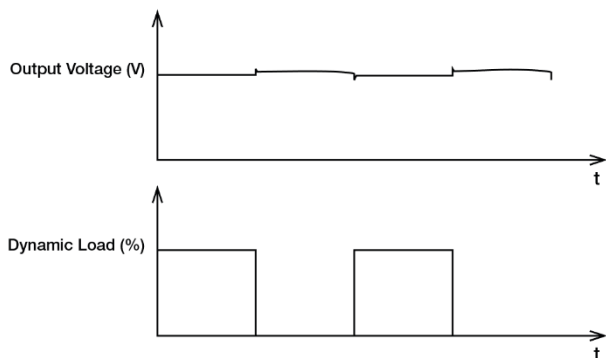

Overvoltage Protection (Latch Off)

The power supply's overvoltage circuit will be activated when its internal feedback circuit fails. The output voltage shall not exceed its specifications defined on Page 4 under "Protections".

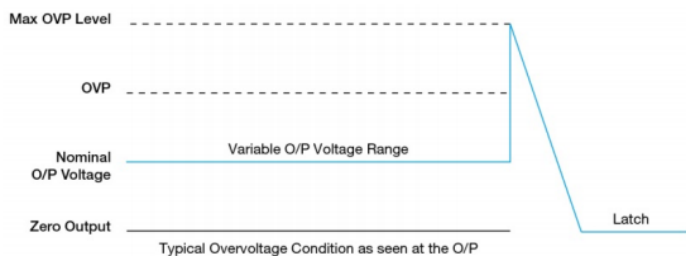

Overload & Overcurrent Protections (Auto-Recovery)

The power supply's Overload (OLP) and Over current (OCP) Protections will be activated when output current exceeds 105% of I_o (Max load). In such occurrence, the V_o will start to droop and once the power supply has reached its maximum power limit, the protection is activated and the power supply will go into "Hiccup mode" (Auto-Recovery). The power supply will recover once the fault condition of the OLP and OCP is removed and I_o is back within the specifications.

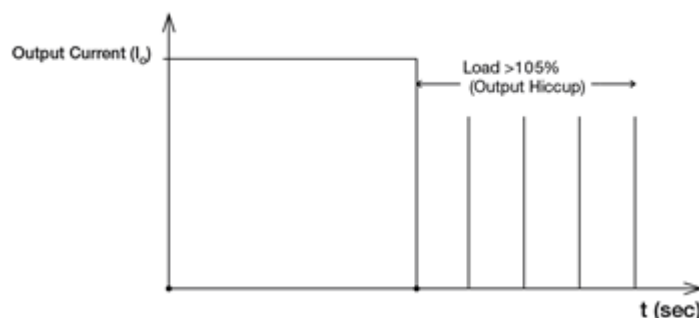

Additionally, if the I_o is $< 105\%$ but $> 100\%$ for a prolonged period of time (depending on the load), the Over Temperature Protection (OTP) will be activated due to high temperature on critical components. The power supply will then go into "Hiccup mode" until power supply cool down.

Over Temperature Protection (Latch Off)

As mentioned above, the power supply also has Over Temperature Protection (OTP). This is activated when the overload condition persists for an extended duration and the output current is below the overload trigger point but $> 100\%$ load. In the event of a higher operating condition at 100% load, the power supply will run into OTP when the surrounding air temperature is $> 50^\circ\text{C}$. When activated, the output voltage will go into latch off mode until the operating surrounding temperature drops to its normal as recommended in the de-rating graph.

Short Circuit Protection

The power supply's output OLP/OCP function also provides protection against short circuits. When a short circuit is applied, the output current will operate in "Hiccup mode", as shown in the illustration in the OLP/OCP section on this page. The power supply will return to normal operation after the short circuit is removed.

Medical AC-DC Power Supply

24 V 500 W 1 Phase / MEB-500A24F AA

Others

PFC – Norm EN 61000-3-2

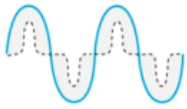

Line Current harmonic

Typically, the input current waveform is not sinusoidal due to the periodical peak charging of the input capacitor. In industrial environment, complying with EN 61000-3-2 is only necessary under special conditions. Complying to this standard can have some technical drawbacks, such as lower efficiency as well as some commercial aspects such as higher purchasing costs. Frequently, the user does not profit from fulfilling this standard, therefore, it is important to know whether it is mandatory to meet this standard for a specific application.

This product conforms to this standard.

Attention

Delta provides all information in the datasheets on an "AS IS" basis and does not offer any kind of warranty through the information for using the product. In the event of any discrepancy between the information in the catalog and datasheets, the datasheets shall prevail (please refer to PSU.deltaww.com for the latest datasheets information). Delta shall have no liability of indemnification for any claim or action arising from any error for the provided information in the datasheets. Customer shall take its responsibility for evaluation of using the product before placing an order with Delta.

Delta reserves the right to make changes to the information described in the datasheets without notice.

Manufacturer and Authorized Representatives Information

Manufacturer

Thailand

Delta Electronics (Thailand) PCL.
909 Pattana 1 Rd., Muang, Samutprakarn, 10280 Thailand

Taiwan

Delta Electronics, Inc.
3 Tungyuan Road, Chungli Industrial Zone, Taoyuan County
32063, Taiwan

Authorized Representatives

The Netherlands

Delta Greentech (Netherlands) B.V.
Zandsteen 15, 2132 MZ Hoofddorp, The Netherlands

United Kingdom

Delta Electronics Europe Limited
1 Redwood Court, Peel Park Campus,
East Kilbride, Glasgow, G74 5PF, United Kingdom